

**Rail 303**  
**Operating Guide February 2007**



**IMPORTANT**  
**You must set the meter to match**  
**the Current Transformers**  
**see pages 3,4 & 5**

**Safety**

**1 Safety**

This instruction manual gives details of safe installation and operation of the **PowerRail 303** electricity meter. Safety may be impaired if the instructions are not followed. Labels on each meter give details of equipment ratings for safe operation. Take time to examine all labels before commencing installation. Safety symbols on the meter have specific meanings.



Refer To User Manual



Risk of Electric Shock

**WARNING**  
The meter contains no user serviceable parts. Installation and commissioning should only be carried out by qualified personnel

Further information is available at <http://www.ndmeter.co.uk>.

**Operation**

**2 Operation**

**2.1 Energy Displays**

**2.2 Total kWh Register**

This default display presented on power up shows total kWh on an 8-digit accumulating register. Register scaling is determined by user programmed CT and/or PT constants. On standard **PowerRail** meters this register may not be reset.

**2.3 kWh Count Register**

The kWh Count display is a 7-digit resettable accumulating energy register. This acts in a similar manner to the "Trip" display on a vehicle odometer.

- Press the **kWh** key to select **Total kWh** or **kWh Count** display pages. The **kWh Count** display remains visible for 1 minute before the unit reverts to **Total kWh** mode.
- Press and hold the **kW** and **kWh** keys for approximately 5 seconds to reset the **kWh Count** register to zero.



Scaling of the energy registers is set by the nominal input currents and voltages and remains constant during normal operation of the meter. Energy registers will accumulate from zero to 99999999, and then restart from zero. If no keys are pressed, the meter will automatically revert to the **Total kWh** Register display after 60 seconds. Both energy registers are stored in non-volatile memory during power loss to the meter.

**Operation**

**2.4 Instantaneous kW Display**

Press **kW**



Instantaneous Power

**2.4.1 REV CT**

The instantaneous power display may show negative values indicating export power or incorrectly wired inputs. **REV CT** will also be shown indicating that the most likely cause of the negative reading is one or more current transformers fitted the wrong way round on the primary conductor.

**2.5 kW Demand Display (Option)**

Press **kW**



kW Demand

kW demand is only available on meters factory fitted with this option. If the user sets a demand period of **N** minutes (eg 30 minutes) the display will be updated every **N** seconds (eg every 30 seconds). The display shows the average of all kW readings taken over the most recent demand period (eg average over 30 minutes). This average kW parameter is commonly known as kW Demand.

Press **kW**



Peak kW Demand

Peak kW demand is only available on meters factory fitted with the demand option. The display shows the largest value of kW demand recorded since the user last reset it. The peak kW Demand value is stored during power loss to the meter.

**2.5.1 Resetting Peak kW Demand**

To reset Peak kW Demand, press **kWh** and **kW** for approximately 2 seconds, while displaying Peak kW Demand.

## Operation

### 2.6 Setup Display Menu

Each meter is configured to operate in a specific system. The meter settings may be displayed on the LCD in the **Setup Display Menu**.

Hold  for 5 Seconds.



The **CT** value should match the **Nominal Primary** rating of the current transformers fitted with the meter.

Press 



If no external potential transformer (PT) is fitted **Un** is the **Rated Nominal Line-Line Voltage** as detailed on the meter label.  
If a PT is fitted, its secondary voltage should match the Rated Nominal Line-Line Voltage of the meter, **Un** is then programmed as the **Nominal Rated Primary Voltage** of the PT.

Press 

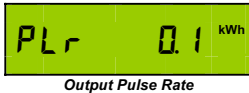

**PLr** indicates the amount of energy accumulated between each pulse output.

Press 



**PLt** indicates the length of time (in seconds) the output pulse contacts remain short circuit for each pulse.

Press 



**OPt** is a code indicating which factory fit options are supplied on an individual meter. This information may be requested when contacting technical support.

## Programming

### 3 Programming



#### 3.1 Programming Menu

To enter programming mode: Hold  and  together for 5 Seconds. The first programmable parameter, CT Primary, is displayed.

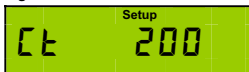
##### 3.1.1 CT Primary Programming



This should be set to match the nominal primary current rating, in Amps, of the external current transformers (CTs) fitted to the meter. The CT secondaries must match the nominal input rating of the meter (5A on standard meters).

Press the up key  or down key  to select CT values from a table of standard primary currents.



Press  when the desired value is set to move to the next parameter.

For primary currents not found in the standard table use fine adjust.

To enter/exit Fine Adjust mode, press  and  together for two seconds.

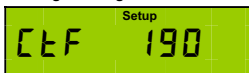
##### 3.1.2 Nominal Primary Current Programming



Press the up key  or down key  to increase/decrease the CT primary setting in steps of 10A.



Press  when the desired value is set to move to the next parameter.

##### 3.1.3 Nominal Voltage Programming



If no external Potential Transformer (PT) is fitted this must be set to match the nominal line-line voltage (Un) of the meter as detailed on its rating label.

If an external PT is fitted this should be set to match the PT nominal primary line-line voltage rating, in volts. The PT secondary must match the nominal input rating of the meter (eg 110V L-L).

Press the up key  or down key  to select values from a table of standard PT primaries.

Press  when the desired value is set to move to the next parameter.

## Operation

Press 



The kW demand period, in minutes, is only displayed on meters supplied with this factory fitted option.

Press 



The baud rate is only displayed on meters supplied with the Modbus serial communication factory fitted option.

Press 



The Modbus address is only displayed on meters supplied with the Modbus serial communication factory fitted option.

### 2.7 Pulse Output

An isolated pulse output is provided for connection to external systems such as Building Energy Management Systems (BEMS), data loggers, remote counters etc.  
A single pulse occurs for each unit of energy on the display (eg 1 pulse per 0.1kWh). The pulse rate (amount of energy associated with each pulse) and pulse length may be set to suit the external system.

#### 2.7.1 Pulse LED

A green LED on the front panel of the instrument pulses ON during each output pulse.





## Programming

For PT primaries not found in the standard table use fine adjust.

To enter/exit Fine Adjust mode, press  and  together for two seconds.





Press the up key  or down key  to increase/decrease the PT setting in steps of 10V.

Press  when the desired value is set to move to the next parameter.

##### 3.1.5 Pulse Output Rate Programming



This sets the amount of energy measured between each pulse output. The scaling is dependant on the display scaling and therefore on the CT and PT programming.



Press  or  to select pulse rates from a table.

Press  when the desired value is set to move to the next parameter.

##### 3.1.6 Pulse Output Length Programming



This sets the length, in seconds, of each pulse.

Press  or  to select pulse lengths (in seconds) from a table.

Press  when the desired value is set to move to the next parameter.

##### 3.1.7 Pulse Output Testing



The pulse test facility allows the pulse output hardware and external system connections to be commissioned without a measured load. The LCD shows **Pto** (off) and **Ptr** (run) and the number of test pulses output. The test pulse rate is set automatically dependant on the programmed pulse length (maximum 0.5Hz).

Press  to start/stop the test pulses.

Press  and  together to stop the test pulses and simultaneously reset the test counter.

Press  when the test is complete to move to the next parameter.

3.1.8 KW Demand Period Programming

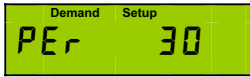

This sets the time, in minutes, over which kW Demand measurements are averaged. This is sometimes referred to as the sliding window or rolling average period.

Press  $\uparrow$  or  $\downarrow$  to increase/decrease the kW Demand period.

Press  $\rightarrow$  when the desired value is set to move to the next parameter.

3.1.9 Baud Rate Programming



This sets the Baud Rate of the serial communications if the Modbus option is fitted at the factory.

Press  $\uparrow$  or  $\downarrow$  to select the desired baud rate from a table

Press  $\rightarrow$  when the desired value is set to move to the next parameter.

3.1.10 Modbus ID Programming



This sets the meters unique communications network ID (Modbus address) if the Modbus option is fitted at the factory.

Press  $\uparrow$  or  $\downarrow$  to increase/decrease the value.

Press  $\rightarrow$  when the desired value is set to complete programming.



The programmed values are saved to non-volatile memory which is secure in the event of a loss of auxiliary power to the meter.

4 Display Scaling

The units, Wh, kWh or MWh and the position of the decimal point for the energy/power displays are automatically set dependant on the **Ct** and **Un** settings for the meter.

The nominal 3-phase input for the meter is defined as:

$$W_{nom} = 1.732 \times Un \times Ct$$

The display pages are scaled as follows:

$W_{nom}$	kW Resolution	kWh Resolution
< 243 W	0.1W	0.001 kWh
< 2.43 kW	0.1W	0.001 kWh
< 24.3 kW	0.001 kW	0.01 kWh
< 243 kW	0.01 kW	0.1 kWh
< 2.43 MW	0.1 kW	1 kWh
< 24.3 MW	1 kW	0.01 MWh
< 243 MW	0.01 MW	0.1 MWh
> 243 MW	0.1 MW	1 MWh

Commissioning

5 Commissioning

5.1 Standard Connections

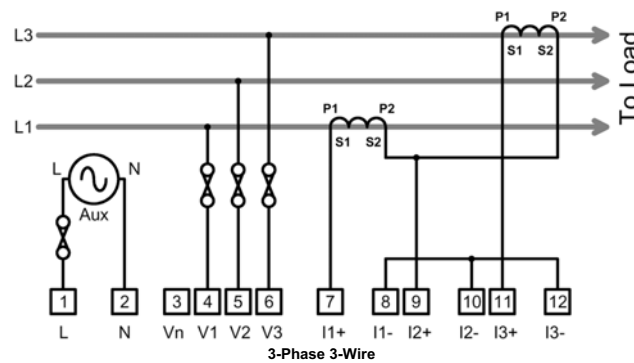
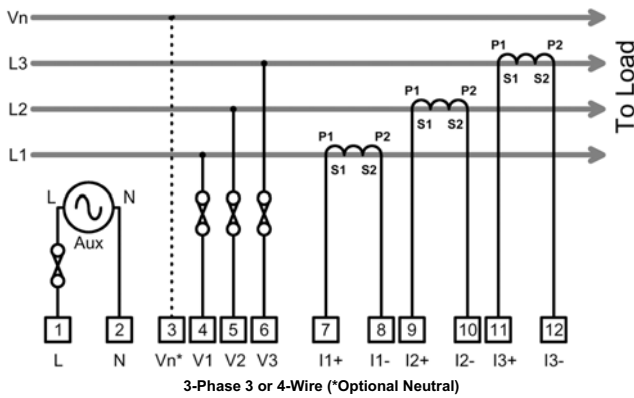

Commissioning

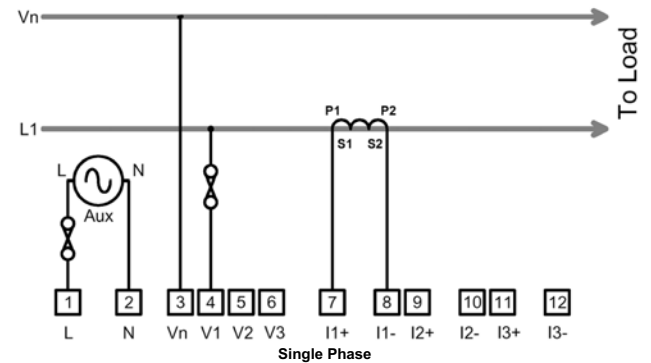
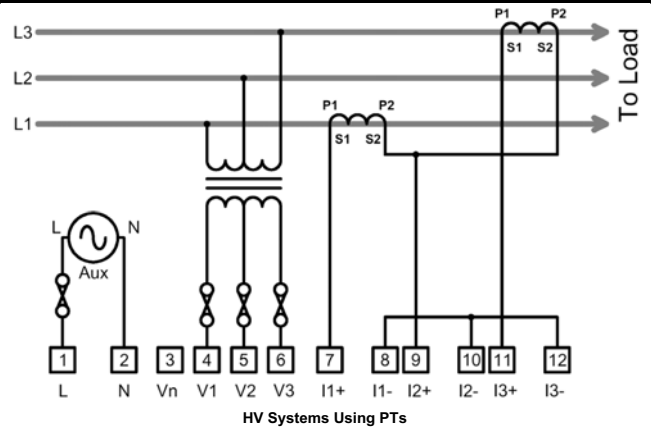

## Commissioning

### 5.2 Pulse Output Connection

The pulse output takes the form of an isolated volt free normally open contact pair. The contacts are isolated from all other circuits (2.5kV / 1 minute).

The pulse can be used as an input to a remote counter, pulse logger, building energy management system etc.

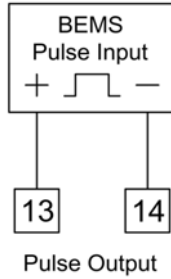

### 5.3 Rail Mounting

The **PowerRail 303** enclosure conforms to DIN 43880, 6 Modules wide. The unit is therefore compatible with a number of standard DIN distribution systems with 45mm cut-outs. The **Power Rail 303** should be mounted on a 35mm, symmetric DIN rail of minimum length 106mm.

## Specification

### 6 Specification

<b>Aux Mains</b>	Nominal 230Vac $\pm$ 15%, 45-65Hz, 1W max. Optional 115Vac $\pm$ 15%.
<b>Input Voltage</b>	Un 400V Line-Line. Range 20%-120% Un Burden 0.1VA / Phase. Overload 2xUn Continuous. Other nominal voltages are available to order.
<b>Input Currents</b>	Nominal Ib = 5A. Range 0.2%-120% Ib Burden 0.1VA / Phase. Overload 20xIb (1 sec) Isolation 2.5kV (1 minute) Optional Ib = 1A
<b>Accuracy</b>	KWh: Class 1. EN62053-21 & BS8431 (2% - 120% Nominal Load) KW: 1% Rdg (5% - 120% Nominal Load)
<b>LCD Display</b>	Green Backlit LCD 8 Digits h=9mm + Legends. kWh Memory 10 years without power.
<b>Pulse Output</b>	Normally open volt free contacts 1 pulse per energy increment. Pulse rate and length selectable. Contacts: 100V ac/dc, 100mA, 5W max Isolation 2.5kV for 1 minute.
<b>Environment</b>	Operate -10C > T < 65C. RH < 75% Non Condensing Storage -25C > T < 75C
<b>Other</b>	<b>Size:</b> 106 x 90 x 58mm <b>Cut out:</b> 106 x 45mm <b>Case:</b> Noryl UL94 V-0 Self Extinguishing <b>Terminals:</b> Rising Cage 4.0mm <sup>2</sup> <b>Weight:</b> Approx 250g