



Stephen P. Wales Ltd

The Old Brewery Works, Lr Ellacombe Church Rd,
Torquay, UK, TQ1 1JH
Tel: 01803 295430 Fax: 01803 212819
email: sales@stephenpwales.co.uk

Sheet number: 401

Operating Guide March 2006



Safety

Cube400

1 Safety

This manual represents your meter as manufactured at the time of publication. It assumes standard software. Special versions of software may be fitted, in which case you will be provided with additional details.

Every effort has been made to ensure that the information in this manual is complete and accurate. We revised this manual but cannot be held responsible for errors or omissions.

The apparatus has been designed and tested in accordance with EN 61010-1, 'Safety Requirements for Electrical Equipment for Measurement, Control and Laboratory Use'. This operating guide contains information and warnings which must be followed by the user to ensure safe operation and to maintain the apparatus in a safe condition.

We reserve the right to make changes and improvements to the product without obligation to incorporate these changes and improvements into units previously shipped.

1.1 Warning Symbols

This instruction manual gives details of safe installation and operation of the **Cube400** electricity meter. Safety may be impaired if the instructions are not followed. Labels on each meter give details of equipment ratings for safe operation. Take time to examine all labels before commencing installation. Safety symbols on the meter have specific meanings.



Refer To User Manual



Risk of Electric Shock

WARNING

The meter contains no user serviceable parts.
Installation and commissioning should only be carried out by qualified personnel

1.2 Maintenance

The equipment should be maintained in good working order. Damage to the product should be repaired by the manufacturer. The meter may be cleaned by wiping lightly with a soft cloth. No solvents or cleaning agents should be used. All inputs and supplies must be isolated before cleaning any part of the equipment.

Further information is available at <http://www.ndmeter.co.uk>.

1.3 Waste Electrical/Electronic Equipment

At the end of this products useful life it should be disposed of ONLY via a recycling center as defined by the EU WEEE directive. This product should not be incinerated.

Cube400

Display

2 Display Pages

Measured data is displayed on numerous pages organised in four Standard Menus and two Distortion Menus as follows:

2.1 Power Up

The following screen is shown when auxiliary power is first supplied.

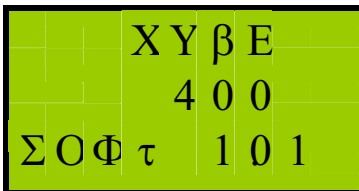

2.2 Current Menu

Press the **[4]** key to select from the available Current Menu pages.

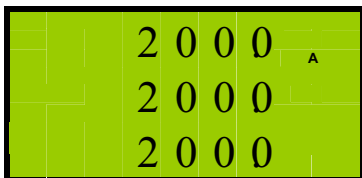

Phase Amps

Phase 1 true rms amps
Phase 2 true rms amps.
Phase 3 true rms amps.
This display is updated every second.

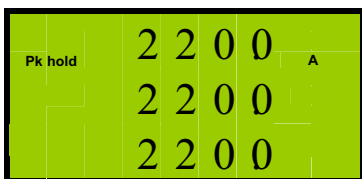

Peak Hold Phase Amps

The maximum value of displayed phase amps. These are stored in non-volatile memory when the meter loses auxiliary power

Press **[4]** and **[V]** to reset all three maximums to zero ^{note 1}.

Page 2

Cube 400

Display

Cube400

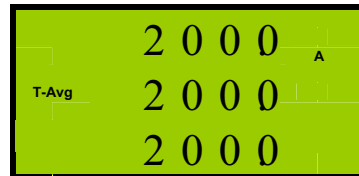

Time-Averaged Amps

The calculated average of phase amps taken over a user definable time period T_{AV} (10s to 1800s). A rolling time window is used and the display updated every $T_{AV}/10$ with the average of the most recent period displayed.

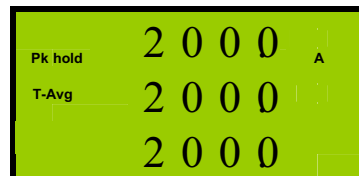

Peak Time-Averaged Amps

The maximum value of Time-Averaged amps. These are stored in non-volatile memory when the meter loses auxiliary power

Press **[4]** and **[V]** to reset all three maximums to zero ^{note 1}.

2.3 Voltage Menu

Press the **[5]** key to select from the available Voltage Menu pages.

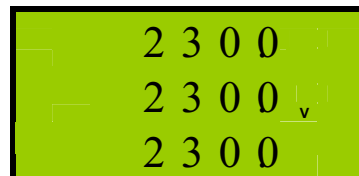

Phase Volts

Phase 1 to neutral true rms volts
Phase 2 to neutral true rms volts.
Phase 3 to neutral true rms volts.
This display is updated every second.

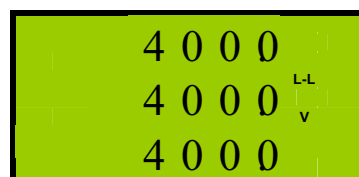

Line Volts

Line 1 true rms volts (Phases 1-2)
Line 2 true rms volts (Phases 2-3)
Line 3 true rms volts (Phases 3-1)
This display is updated every second.

Cube400

Page 3

Page 4

Cube 400

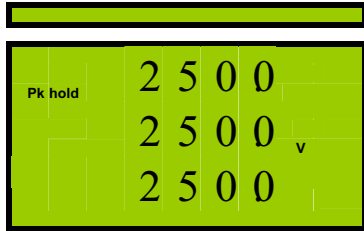

Peak Hold Phase Volts

The maximum value of displayed phase volts. These are stored in non-volatile memory when the meter loses auxiliary power

Press **↓** and **↕** to reset all three maximums to zero ^{note 1}.

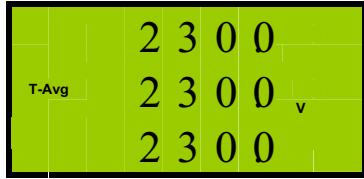

Time-Averaged Volts

The calculated average of phase volts taken over a user definable time period T_{Vi} (10s to 1800s).

A rolling time window is used and the display updated every $T_{Vi}/10$ with the average of the most recent period displayed.

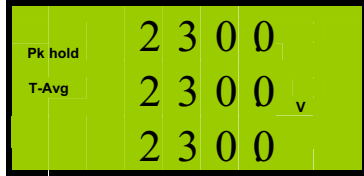

Peak Time-Averaged Volts

The maximum value of Time-Averaged volts. These are stored in non-volatile memory when the meter loses auxiliary power

Press **↓** and **↕** to reset all three maximums to zero ^{note 1}.

2.4 Power Menu

Press the **P** key to select from the available Power Menu pages.

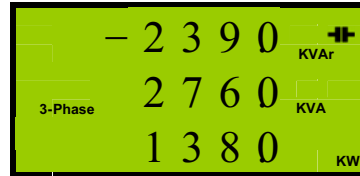

System Power

System Reactive Power (var)
System Active Power (VA)
System Real Power (Watts)
A **+** symbol after the var value indicates a capacitive load.
A negative sign before the var readings indicates export reactive power.

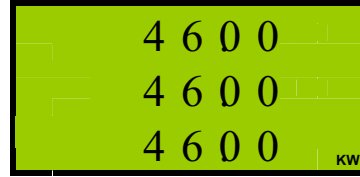

Phase Watts

Phase 1 true rms watts
Phase 2 true rms watts
Phase 3 true rms watts

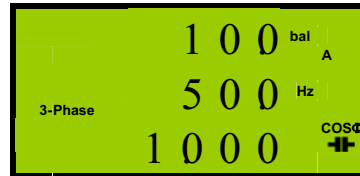

System Page 2

Balance current. (I1+I2+I3)
Frequency (Measured on V1)
System Power Factor
A **+** symbol after the power factor value indicates a capacitive load.

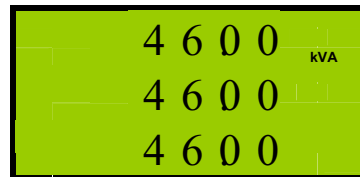

Phase VA

Phase 1 true rms VA
Phase 2 true rms VA.
Phase 3 true rms VA

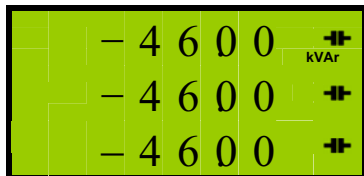

Phase VAR

Phase 1 true rms Var.
Phase 2 true rms Var.
Phase 3 true rms Var.

A **+** symbol after a var value indicates a capacitive load.

A negative sign before a var reading indicates export reactive power.

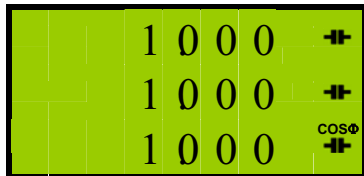

Phase Power Factor

Phase 1 Power Factor.
Phase 2 Power Factor.
Phase 3 Power Factor.

A **+** symbol after each value indicates a capacitive load.

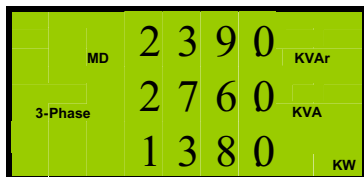

Power Maximum Demand (MD)

The calculated average of the system power values taken over a user definable time period T_P (1min to 60min).

A rolling time window is used and the display updated every $T_P/60$ with the averages of the most recent period displayed.

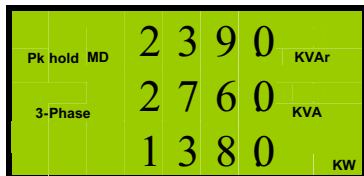

Peak Hold MD

The maximum value of each power MD value. These are stored in non-volatile memory when the meter loses auxiliary power

Press **↓** and **↕** to reset all three maximums to zero ^{note 1}.

NOTE 1: Meters may be installed with the option to reset all peak hold values using the front keys disabled.

2.5 Energy Menu

Press the **E** key to select from the available Energy Menu pages.

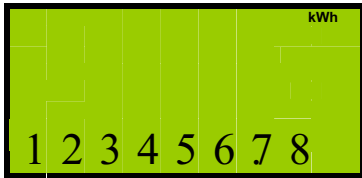

Real Energy (Wh)
This register accumulates only when real power (kW) is positive (import).
This value returns to 0 when the value exceeds 99999999.
This register is stored in non-volatile memory when auxiliary power is not supplied to the meter.

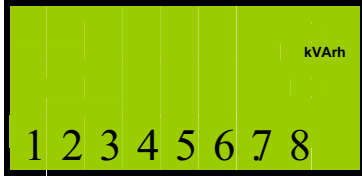

Reactive Energy (VArh)
Import varh Accumulating register.
This value returns to 0 when the value exceeds 99999999.
This register is stored in non-volatile memory when auxiliary power is not supplied to the meter.

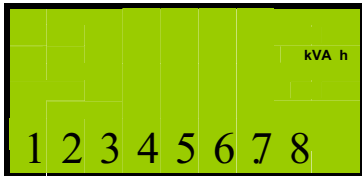

Apparent Energy (VAh)
Import VAh Accumulating register.
This value returns to 0 when the value exceeds 99999999.
This register is stored in non-volatile memory when auxiliary power is not supplied to the meter.

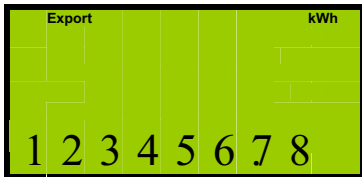

Export kWh^{Note 2}
This register accumulates only when real power (kW) is negative (export).
This value returns to 0 when the value exceeds 99999999.
This register is stored in non-volatile memory when auxiliary power is not supplied to the meter.

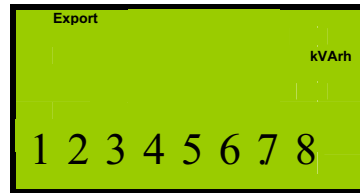

Export kvarh^{Note 2}
This register accumulates only when reactive power (kvar) is negative (export).
This value returns to 0 when the value exceeds 99999999.
This register is stored in non-volatile memory when auxiliary power is not supplied to the meter.

NOTE 2: Export kWh and kvarh are factory fitted options. If these options are not supplied Export page(s) will be omitted.

Meters may be supplied with an option to reset energy registers to zero using the front keys.

If the option is fitted, press **I** and **V** together and hold for approximately 3 seconds to simultaneously reset all energy registers to zero. Once reset the registers may not be recovered.

2.6 Power Quality Menus

To enter/exit power quality display mode press **P** and **E** together and hold for approximately 3 seconds.

2.6.1 Amps Power Quality Menu

Press the **I** key to select the Amps Power Quality Sub Menu. Press **P** or **E** keys to select the next/previous Amps Power Quality page.

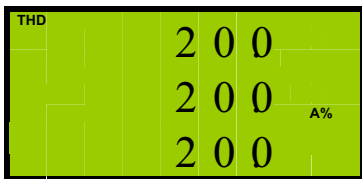

Amps Total Harmonic Distortion
Phase 1 Amps THD
Phase 2 Amps THD.
Phase 3 Amps THD.
This display is updated every second.
THD is scaled as 0-100.0%.

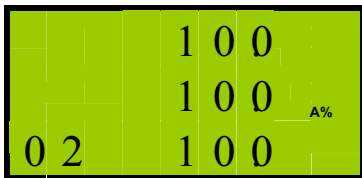

Amps Individual Harmonics 02-15
Phase 1 Amps harmonic 02-15
Phase 2 Amps harmonic 02-15
Phase 3 Amps harmonic 02-15.
The harmonics are scaled as a percentage of the fundamental rms amps value. This example shows 10.0% second harmonic.

2.6.2 Volts Power Quality Menu

Press the **V** key to select the Volts Power Quality Sub Menu. Press **P** or **E** keys to select the next/previous Volts Power Quality page.

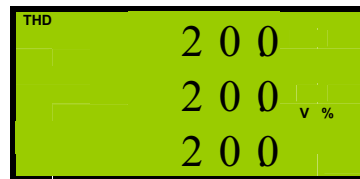

Volts Total Harmonic Distortion
Phase 1 Volts THD
Phase 2 Volts THD.
Phase 3 Volts THD.
This display is updated every second.
THD is scaled as 0-100.0%.

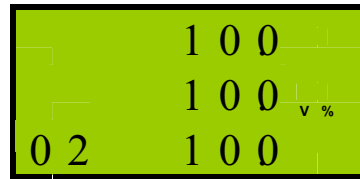

Amps Individual Harmonics 02-15
Phase 1 Volts harmonic 02-15
Phase 2 Volts harmonic 02-15
Phase 3 Volts harmonic 02-15.
The harmonics are scaled as a percentage of the fundamental rms volts value. This example shows 10.0% second harmonic.

2.7 Display Scaling

Measured values displayed on the LCD are scaled by the user settings of CT and/or PT primaries to provide optimum resolution.

2.7.1 Voltage Scaling

PT Setting	Resolution
10V _{L-L} - 80V _{L-L}	0.01 V
81V _{L-L} - 800V	0.1 V
801V _{L-L} - 8,000V _{L-L}	1 V
8,001V _{L-L} - 50,000V _{L-L}	0.01 kV

2.7.2 Current Scaling

CT Setting	Resolution
5A - 8A	0.001 A
9A - 80A	0.01 A
81A - 800A	0.1 A
801A - 8,000A	1 A
8,001A - 20,000A	0.01 kA

2.7.3 Power Scaling (W, VA, var)

PT Setting x CT Setting	Phase Power Resolution	System Power Resolution
100VA - 1,400VA	0.1 W	0.001 kW
1,401VA - 14,000VA	0.001 kW	0.01 kW
14,001VA - 140,000VA	0.01 kW	0.1 kW
140,001VA - 1,400,000VA	0.1 kW	1 kW
1,400,001VA - 14,000,000VA	1 kW	0.01 MW
14,000,001VA - 140,000,000VA	0.01 MW	0.1 MW
140,000,001VA - 1,000,000,000VA	0.1 MW	1 MW

2.7.4 Energy Registers (Wh, VAh, varh)

PT Setting x CT Setting	Resolution
100VA - 1,400VA	.001 kWh
1,401VA - 14,000VA	0.01 kWh
14,001VA - 140,000VA	0.1 kWh
140,001VA - 1,400,000VA	1 kWh
1,400,001VA - 14,000,000VA	0.01 MWh
14,000,001VA - 140,000,000VA	0.1 MWh
140,000,001VA - 1,000,000,000VA	1 MWh

2.7.5 Miscellaneous

All Settings	Resolution
System and Phase PF	0.001
Amps and Volts % THD	0.1%
Amps and Volts % Harmonic	0.1%
Frequency	0.1 hz

3 Connection

3.1 Mounting In a Panel

Panels should be 1mm to 4mm thick with a square cutout of 92mm (+0.8/-0.0mm). Insert the meter from the front of the panel, slide the panel clips from the rear of the case and push firmly against the panel ensuring even pressure on each clip.

3.2 Pulse Output Connection

The pulse outputs take the form of isolated volt free normally open contact pairs. The contacts are isolated from all other circuits (2.5kV / 1 minute) and at 50V from pulse 1 to pulse 2.

The pulses can be used as an input to a remote counter, pulse logger, building energy management system etc.

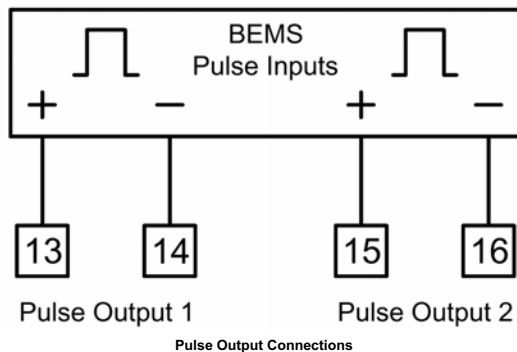

3.3 Input Connections

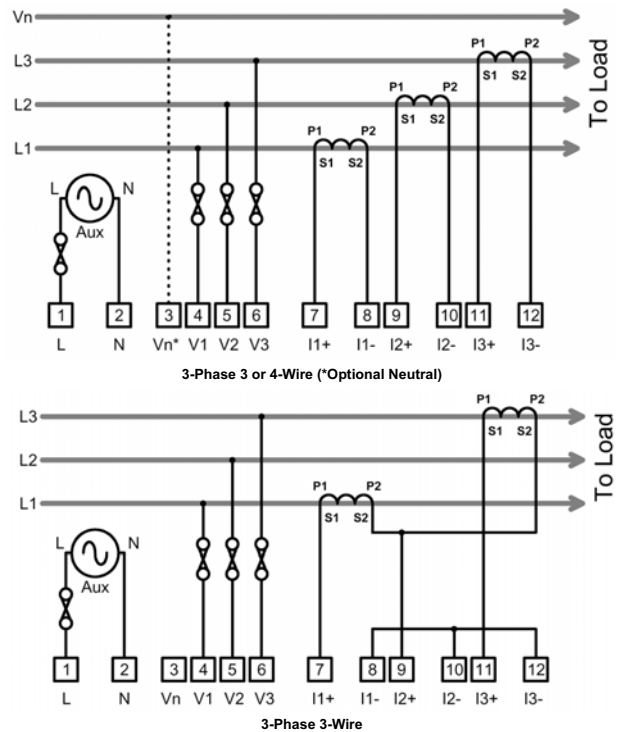

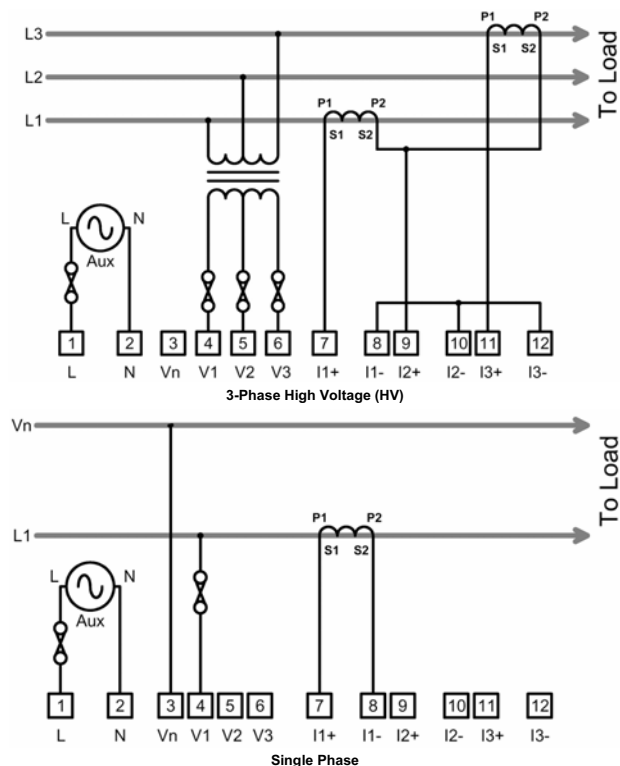

4 Pulse Outputs

Two isolated pulse outputs are provided for connection to external systems such as Building Energy Management Systems (BEMS), data loggers, remote counters etc. Pulse 1 is always associated with the active energy (kWh) register. Pulse 2 is normally associated with the reactive energy (kvarh) register but meters may be supplied with this pulse linked to the kVAh register. A single pulse occurs for each unit of energy on the display (eg 1 pulse per 0.1kWh). The pulse rate (amount of energy associated with each pulse) and pulse length may be set to suit the external system.

4.1.1 Pulse LEDs

Light emitting diodes (LEDs) on the front panel of the instrument remain ON during each associated output pulse.



Pulse Output Indicators

5 Meter Setup

5.1 Programming Menu

To enter programming mode:

Hold **F** and **E** together for 5 Seconds.

4-Digit Security Code

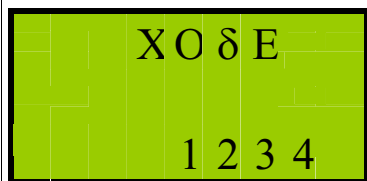

This page is only shown if a security code greater than 0 is set via serial communication.

Press **P** or **E** to select each digit (least significant first)

Press **I** to move to the next most significant digit.

A correct 4 digit security code is required to access other programming menu pages.

Current Transformer Primary

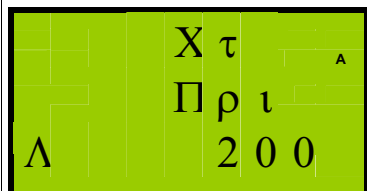

Press **P** or **E** to select from the standard list of CT primaries while **A** is displayed. (List Mode)

Press **P** or **E** to increase or decrease the value by 10 while **Φ** is displayed. (Fine adjust)

Press **I** and **P** together to toggle between **A** and **Φ**.

Press **I** to accept the set value.

Potential Transformer Primary

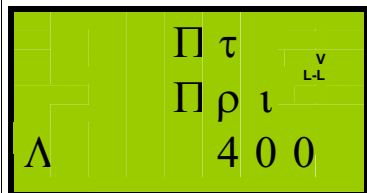

Press **P** or **E** to select from the standard list of PT primaries while **A** is displayed. (List Mode)

Press **P** or **E** to increase or decrease the value by 10 while **Φ** is displayed. (Fine adjust)

Press **I** and **P** together to toggle between **A** and **Φ**.

Press **I** to accept the set value.

Power MD Integration Period

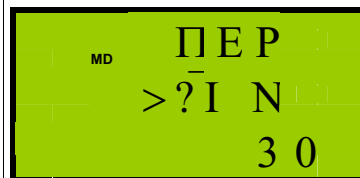

This sets the integration period in minutes used for the sliding time window MD calculation for power.

Press **P** or **E** to increment or decrement the value.

Press **I** to accept the set value.

Current/Voltage Time Average Period



This sets the integration period in seconds used for the sliding time window average calculation for current and voltage.

Press **P** or **E** to increment or decrement the value.

Press **I** to accept the set value.

Pulse Rate



This sets the amount of energy (kWh) required to trigger each Pulse 1 output.

Pulse 2 is set at the same rate but linked to a different register (eg kvarh).

Press **P** or **E** to select the next/previous Pulse Rate from a standard list.

Press **I** to accept the set value.

Pulse Length

This sets the contact closure time for both pulse outputs.

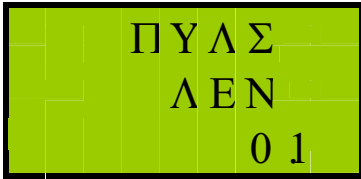

Press **▲** or **▼** to select the next/previous Pulse Length from a standard list.

Press **▶** to accept the set value.

Pulse Test

This allows the commissioning engineer to test both pulse outputs and associated circuits without the need of a test load.



Press **▶** or **◀** to start/stop a test pulse stream. The display shows H.δ (Hold) or PYN respectively.

The counter shows the total number of pulses during the test.

Press **▶** and **▼** to reset the test counter to zero.

Press **▶** to accept the set value.

Specification

Aux Supply	Nominal 230Vac ±15%, 45-65Hz, 1W max. Optional 115Vac ±15%. Isolation 2.5kV (1 minute)
Input Voltage	Un 400V Line-Line. Range 20%-120% Un Burden 0.1VA / Phase. Overload 2xUn Continuous. Other nominal voltages are available to order.
Input Currents	Nominal Ib = 5A. Range 0.2%-120% Ib Burden 0.1VA / Phase. Overload 40xIb (0.5 sec) Isolation 2.5kV (1 minute) (50V Pulse1-Pulse2) Optional Ib = 1A
Accuracy	KWh: Cl.1.EN62053-21 & BS8431 (2-120% Nom kW) Kvarh: Cl.2.0.EN62053-23 KW: 1% Rdg (5% - 120% Nom kW) Amps: 0.2% Ib or 1.0% Rdg (0.05Ib < Iph < 1.2Ib) Volts: 0.2% Un or 1.0% Rdg (0.2Un < Vph < 1.2Un) PF: ±0.2 Degrees Frequency: ±0.05Hz (45Hz [F 65Hz])
LCD Display	LCD 8 Digits h=6.7mm + Legends h=3.2mm. kWh Memory 10 years without power.
Pulse Outputs	Normally open volt free contacts Pulse rate and length selectable. Contacts: 100V ac/dc, 100mA, 5W max Isolation 2.5kV for 1 minute.
Environment	Operate -10°C > T < 65°C. RH < 75% Non Condensing Storage -25C > T < 75C IP 54 (IP65 with optional kit)
Other	Size: 96 x 96 x 83.5mm (72mm behind panel) Case: DIN 96x96mm Mablex UL94-V0 Terminals: Rising Cage 4.0mm ² Weight: Approx 250g